

DX-1210/1220/1230/630/640

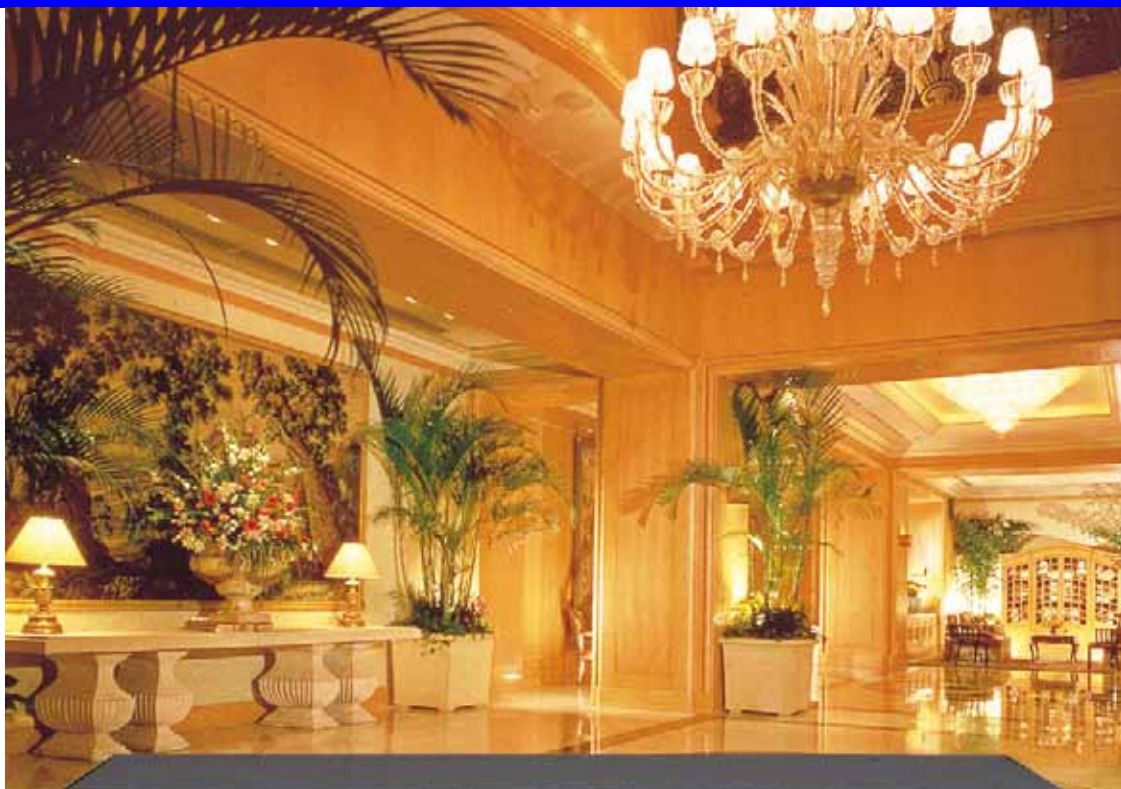

【USER MANUAL】

MODULAR POWER PACK



Lite-puter Enterprise Co., Ltd.

www.liteputer.com.tw

sales@liteputer.com.tw

Index:

The regulation of safe usage:..... 1

Chapter 1. Introduction

1-1 Features of DX-1210/1220/1230/630/640.....	4
1-2 Structure.....	6
1-3 Specification	7

Chapter 2. Installation and function introduction

2-1 Installation.....	8
2-2 The main function of P-27/P-10/P-30/P-40	9
2-3 Introduction of DP-5	10
2-4 Connection of DMX & ANALOG	11
2-5 Real panel	11

Chapter 3. MODE

3-1 DMX mode	12
3-2 ANALOG mode	12
3-3 OFF mode	13
3-4 How to set the start address of channels.....	14
3-5 How to connect with over 2 sets of DX-1210/1220/1230/630/640	15
3-6 How to Lock/ Unlock the function key of DX-1220 Series.....	15

Chapter 4. FUN (FUNCTION)

4-1 Display dimming level of each channel	16
4-2 Dimming level testing for each channel or all channel	17
4-3 Fade in and Fade out automatically testing for each channel or all channels	18
4-4 Display the Voltage.....	18
4-5 Display internal temperature.....	19

Chapter 5. SET

5-1 Set dimmer-warm up 0% --- 6%.....	20
5-2 Set dimming or switch for each channel or all channels.	21
5-3 6 memory scenes --- be use for architectural lighting with CP-2	22
5-4 Set fader time	23
5-5 The corresponding list of setting fader time.....	24
5-6 Set "square" or " 3 linear" dimming curve	25
5-7 Maximum wattage limit setting.....	26

Chapter 6. Specification of plug & wiring diagram

.....	27
-------	----



The regulation of safe usage:

As to DX-1210/1220/1230/630/640's electronic load capacity, please refer our suggestion as follows to maintain the usage time of DX-1210/1220/1230/630/640.

- (1). DX-1210 Maximum output of individual channel is 10A;
DX-1220 Maximum output of individual channel is 25A;
DX-1230 Maximum output of individual channel is 30A:
For the moments testing. (about 30 minutes.)
DX-630 Maximum output of individual channel is 32A;
DX-640 Maximum output of individual channel is 40A:
For the moments testing. (about 10 minutes.)**
- (2). DX-1210 Output of individual channel $\leq 10A$;
DX-1220 Output of individual channel $\leq 20A$;
DX-1230 Output of individual channel $\leq 25A$;
DX-630 Output of individual channel $\leq 30A$;
DX-640 Output of individual channel $\leq 35A$:
For many hours . (It's used for a theater or a stage.)**
- (3). DX-1210 Output of individual channel $\leq 10A$;
DX-1220 Output of individual channel $\leq 12A$;
DX-1230 Output of individual channel $\leq 18A$;
DX-630 Output of individual channel $\leq 20A$;
DX-640 Output of individual channel $\leq 30A$;
Continue working for the whole years.
(It's used for hotels or restaurants.)**
- (4). Individual channel must be set dimming or switching function before the load switch (circuit breaker) turns on.
The non-dimming lamp may be damaged in dimming function. Please refer section 5-2.**

■ **To Use Environment :**

1. Air Temperature : under 35°C
2. Case Inside Temperature : under 45°C
3. Humidity : 40% --- 80%

Lite-Puter provide DX-F02 (Fluorescent dc dimmer module) to control the DC fluorescent dimming.

Chapter 1. Introduction

DX-1210/1220/1230/630/640, a digital DMX 12 or 6 channel modular power pack. This new sophisticated power pack is ideal and reliable for stage lighting, disco night club, as well as Architectural lighting.

The Lite-Puter **DX-1210/1220/1230/630/640** is just not another ordinary power pack, but has the versatility to meet your needs plus more. The smoothest lighting effects in its class as well as it's quick maintenance makes the **DX-1210/1220/1230/630/640** an ideal power pack.

You will be pleased with not only the ability to change a module without turning off all power, but also the ability to remove any amount of modules without removing the whole unit. The **DX-1210/1220/1230/630/640** has a variety of functions and testing keys to help the user get maximum usage.

1-1 Features of DX-1210/1220/1230/630/640

- It's suitable for theaters, stages, and architectural lighting system.
- It can be accepted either DMX-512 signal or Analog 0-10V DC signal.
- Auto frequency tracking:
45 --- 63Hz can be adjusted automatically.
- Digital dimming:

- Each channel can be set in dimming or in switch.
- Square law and Linear dimming curve can be chosen.
- Dimming test for each channel or all channels.
- 90-240 VAC can be changed automatically.
- Maximum voltage limit setting.
- LED displays DMX address and voltage, dimming level and temperature.
- Each or all channels can be set warm-up 0--6.0% to protecting lamps.
- 6 scenes memorized.

(It's used for architectural lighting system with CP-2A or CP-3B.)

1-2 Structure

- **Modular design:**

It is easy to replace, repair and change each independent module and update software in DP-5 CPU interface.

- (DX-1210 ues 10A;DX-1220 ues 25A; DX-1230 use 30A; DX-630 ues 32A; DX-640 ues 40A) magnetic circuit breaker on each P-10/P-27/P-30/P-30A/P40A.

- **Two temperature-controlled fans.**

When the internal temperature is over 34°C, the fans start to work 1 minute and stop 1 minute in turn;
 over to 37°C, the fans turn continuously;
 over 63°C, all output will be stopped until the temperature goes down 60°C.

- **SSR : 40A/600V (75°C) Itrms=40A
 Itsm=350A / 60HZ , 300A / 50HZ (25°C)
 According with UL 81734**

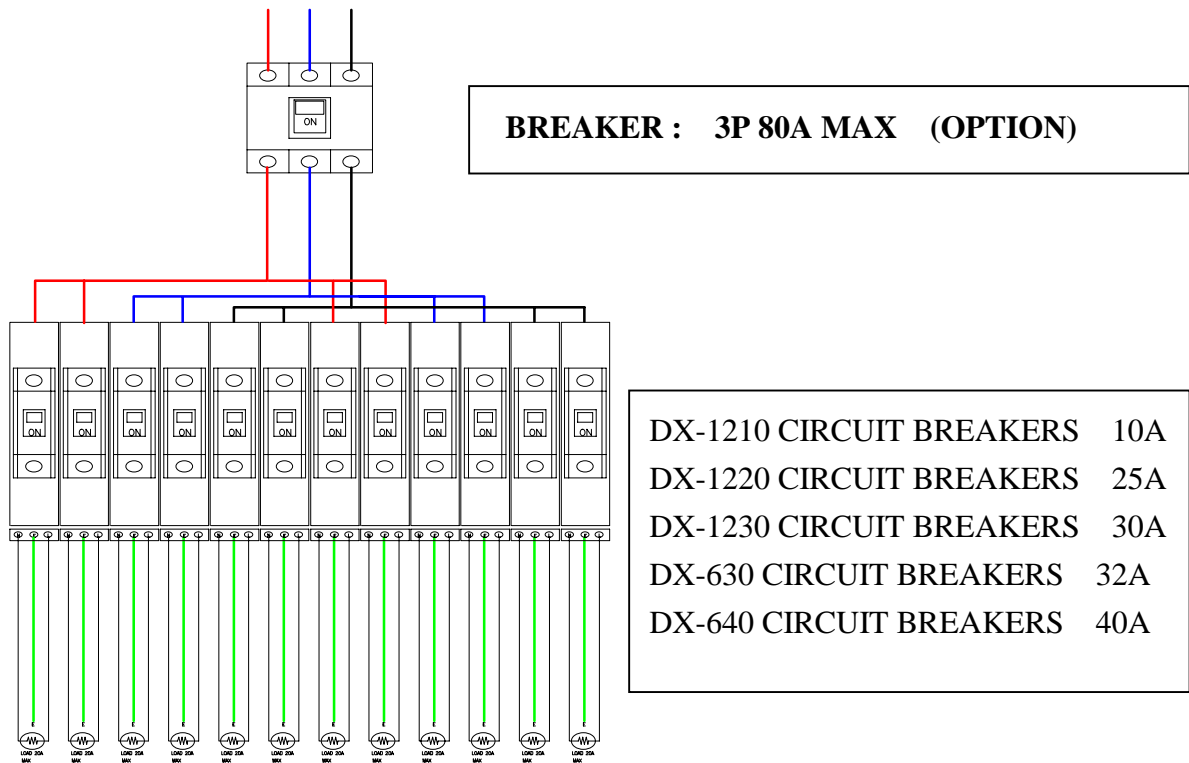

1-3 Speciafication

■ AC INPUT:	100V-120V or 200V-240V 45-63HZ 3 phases 4 wires or single phase 3 wires.
■ LOAD:	DX-1210 10A MAX output per channel DX-1220 20A MAX output per channel DX-1230 30A MAX output per channel DX-630 30A MAX output per channel DX-640 40A MAX output per channel
■ Analog signal input valtage:	0-10V DC
■ Analog signal input channel (D TYPE 15pin)	DX-1210/1220/1230 has 12 cannels ; DX-630/640 has 6 channels PIN 1-12: CH1---12, PIN 13: NC, PIN 14: V+12V, PIN 15: GND
■ Analog signal connector	D TYPE connector 15 PIN
■ DMX signal (5 pin XLR)	DMX512 / 1990
■ DMX signal input channel	512 channels
■ DMX signal input connector	XLR 5-pin
■ Dimension: 19" 4U	482(L) x 176(H) x 260(D)mm
■ Weight:	DX-1210 : 20 KG ; DX-1220 : 21 KG ; DX-1230 : 23 KG ; DX-630 : 17 KG ; DX-640 : 20 KG ;

DX-1210/1220/1230/630/640 meets with specialfication as follows:

1. EN 55014
2. EN 61000-3-2
3. EN 61000-3-3
4. EN 50140
5. EN 61000-4-2
6. EN 61000-4-4
7. EN 61000-4-5
8. EN 61000-4-11
9. ENV 50141



Chapter 2. Installation and function introduction

2-1 installation

(DX-1210 is composed of 12 pieces of P-10 ;DX-1220 is composed of 12 pieces of P-27 ; DX-1230 is composed of 12 pieces of P-30 ; DX-630 is composed of 6 pieces of P-30A ; DX-640 is composed of 6 pieces of P-40A) (One channel module) and 1 set of "DP-5" (DMX interface). The modular design is for easy to replace, repair and change update software fast.

Front panel



2-2 The main function of P-10/P-27/P-30/P-30A/P-40A

P-10/P-27/P-30 (One Channel Driver Module)



P-30A/P-40A (One Channel Driver Module)



(1) UNLOCK / LOCK KNOB: PULL-UNLOCK, PUSH-LOCK.
(2) AC OUTPUT INDICATOR.
(3) TRIG INDICATOR.
(4) 25A MAGNETIC CIRCUIT BREAKER.
(5) VENTILATOR

2-3 Introduction of DP-5

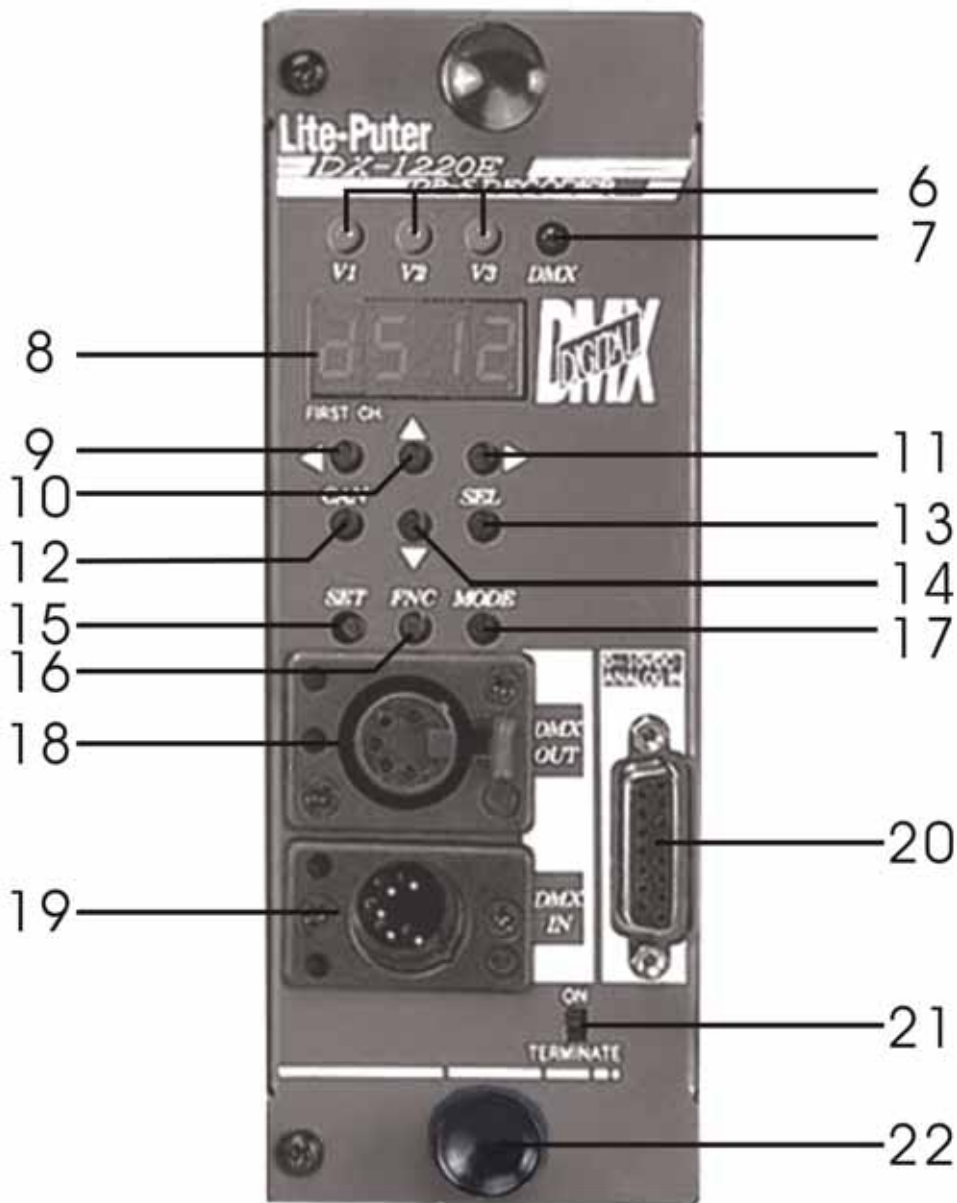

(6) PHASE INPUT INDICATORS	(7) DMX SIGNAL INPUT INDICATOR
(8) LED DISPLAY	(9) ◀ BUTTON
(10) ▲ BUTTON	(11) ▶ BUTTON
(12) CANCEL BUTTON	(13) SELECT BUTTON
(14) ▼ BUTTON	(15) SET / SETTING BUTTON
(16) FUNCTION BUTTON	(17) MODE BUTTON
(18) 5 PIN DMX "OUT" CONNECTOR	(19) 5 PIN DMX "IN" CONNECTOR
(20) ANALOG "IN" CONNECTOR (0-10VDC)	(21) TERMINATE SWITCH
(22) UNLOCK / LOCK KNOB: PULL-UNLOCK / PUSH-LOCK	

2- 4 Connection of DMX & ANALOG

DMX Connector

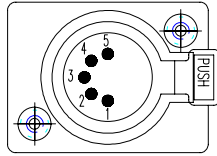

DMX OUT

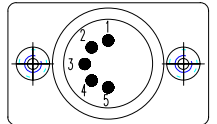

DMX IN

- 1: GND
- 2: D-
- 3: D+
- 4: NC
- 5: NC

DMX Connection XLR 5pin

- PIN 1: GND**
- PIN 2: DATA -**
- PIN 3: DATA +**
- PIN 4: NC**
- PIN 5: NC**

Analog Connection D-type 15pin

- PIN 1: CH-1**
- PIN 2: CH-2**
- PIN 3: CH-3**
-
-
- PIN 12: CH-12**
- PIN 13: NC**
- PIN 14: DC OUTPUT**
+12V / 100mA
- PIN 15: GND**

Analog Connector

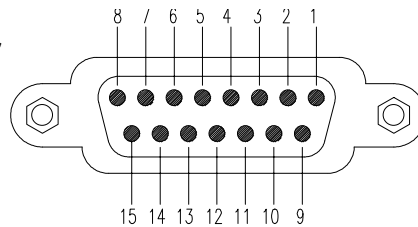

2-5 REAL PANEL

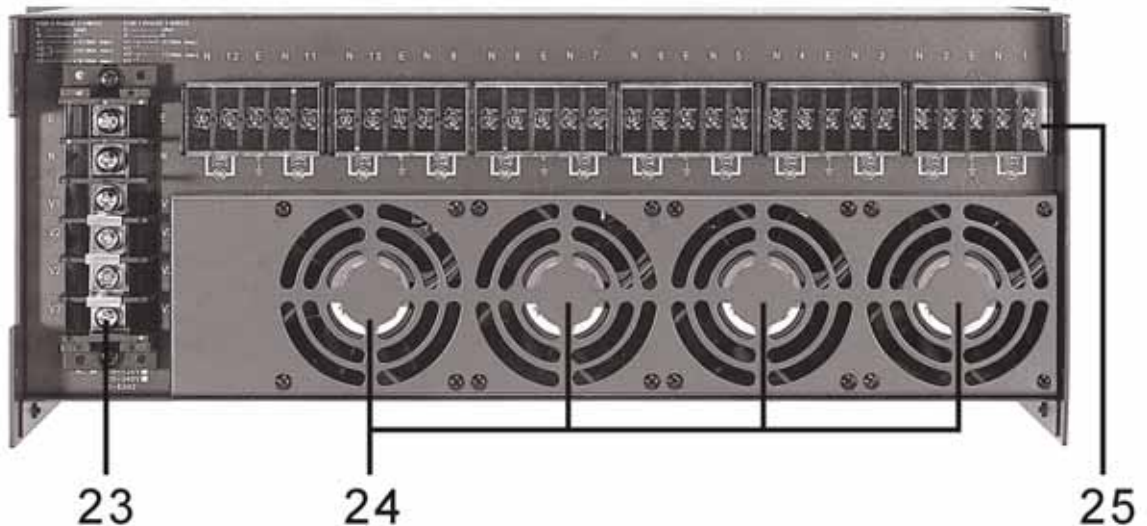

(23) AC Main power input terminal 3phases 4wires.

(24) Temperature-controlled fans.

(25) Load output terminal

Chapter 3. **MODE**

Press "MODE" key

DX-1220 series will offer 3 operation modes:

"DMX" , "ANALOG" and "OFF" mode.

3-1 **DMX mode**

In the DMX mode, DX-1210/1220/1230/630/640 will accept DMX-512 dimming signal input also analog 0 --- 10vDC signal.

Operation:

Press "MODE" key to choose **DMX mode**, the LED will display the selected address of DMX as follows, and then press "SEL" key to confirm.

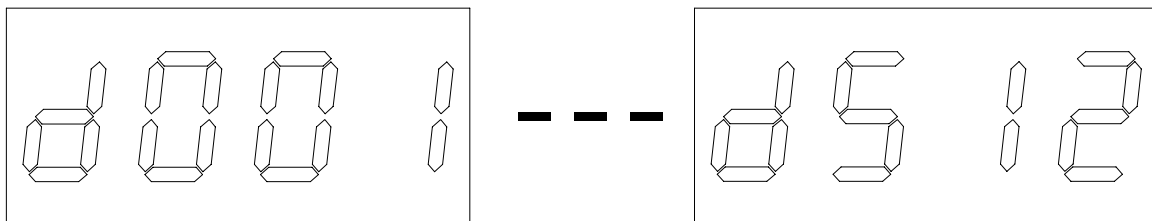

3-2 **ANALOG mode**

In the ANALOG mode, DX-1220 will only accept ANALOG signal input.

Operation:

Press "MODE" key to choose **ANALOG mode**, the LED will display as follows, and then press "SEL" to confirm.

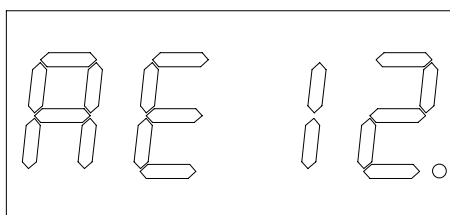

3-3 OFF mode

In the OFF mode, **DX-1210/1220/1230/630/640** will not accept any signal.

Operation:

Press "**MODE**" key to choose **OFF mode**, the LED will be display as follows, and then press "**SEL**" to confirm.

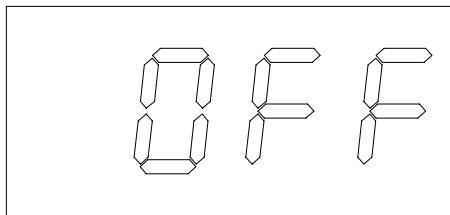

When system is turned on, memory resets to last selected mode prior to turning off. For example, if "OFF" mode was selected, then "OFF" mode continues when system is turned on.

3-4 How to set the start address of channels

Operation:

Press "MODE" key to choice **DMX mode**, and then press the assist key to confirm the correct start address of DMX channels.

Assist key:

Press [**▶**] : Increase channel

eg: Led display from d 0 0 1 to d 0 0 2.

Press [**◀**] : Decrease channel

eg: Led display from d 0 0 2 to d 0 0 1.

Press [**▲**] : DX-1210/1220/1230 increases 12 addresses ◦

For instance : d 0 0 1 becomes d 0 1 3

DX-630/640 increases 6 addresses ◦

For instance : d 0 0 1 becomes d 0 0 7

Increase 12 channels.

eg: Led display from d 0 0 1 to d 0 1 3.

Press [**▼**] : Restore back to d 0 0 1.

Press [**SEL**] : Select / Confirmation key.

PS: (1) In the DMX mode, total 512 channels can be set start address by users.

(Each DX-1210/1220/1230 can make output 12 channels in a row)

For example :

initial address is d 0 0 1 , DMX output from 1st channel to 12th channel

initial address is d 0 1 3, DMX output from 13th channel to 24th channel

(Each DX-630/640 can make output 6 channels in a row)

For example :

initial address is d 0 0 1 , DMX output from 1st channel to 6th channel

initial address is d 0 1 3, DMX output from 13th channel to 18th channel

(2) DX-1220 series can be set same address over 2 sets of DX-1220 series.

3-5 How to connect with over 2 sets of DX-1220 series

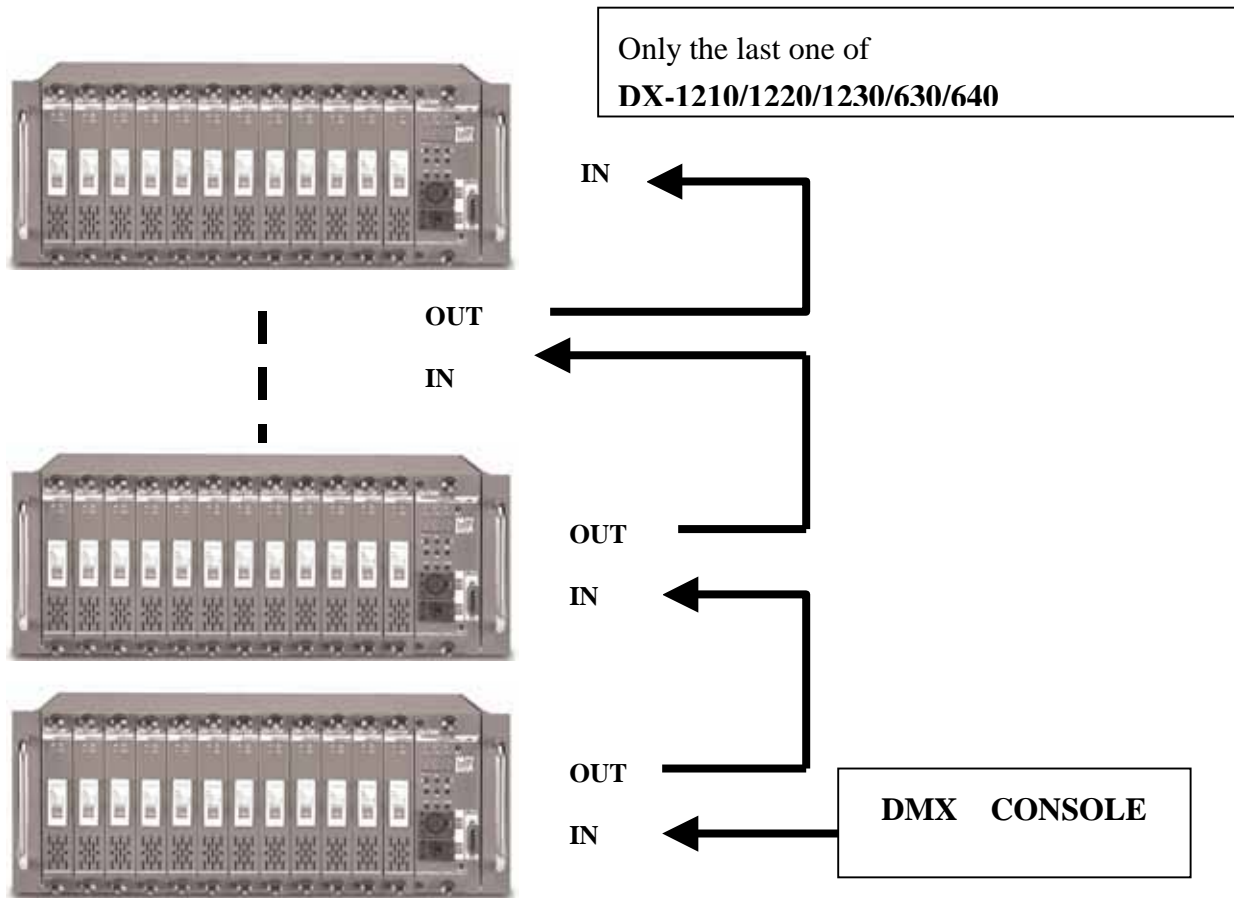

Important:

When a system is composed of several DX-1210/1220/1230/630/640, only the terminate switch of the last DX-1210/1220/1230/630/640 stays "on" to keep fine communication, and the others stay "off".

3-6 How to Lock/ Unlock the function key of DX-1220 series

LOCK: PRESS [FNC] + [MODE] + [^]

UNLOCK: PRESS [FNC] + [MODE] + [v]

Chapter 4. FUN (FUNCTION)

Press "FUN" key in turn and the LED will display 5 functions as follows:

- (1) Displays dimming level of each channel.
- (2) Set dimming level testing for each channel or all channels.
- (3) Fade in and fade out automatical testing for each channel or all channels.
- (4) Display the AC voltage .
- (5) Display internal temperature.

4-1 Display dimming level of each channel

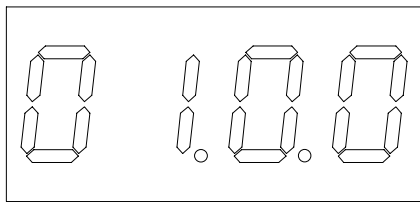

Auto scan to the dimming level of each channel.

Channel number

Dimming Level is 00 -- FL(100%)

Auto scan or by manual is optional.

Indicator Key: By manual

Press [**▶**] : Increase 1 channel.

Eg.: Led display from 0 1.0.0 to 0 2.0.0

Press [**◀**] : Decrease 1 channel.

Eg.: Led display from 0 2.0.0 to 0 1.0.0

4-2 Dimming level testing for each channel or all channels.

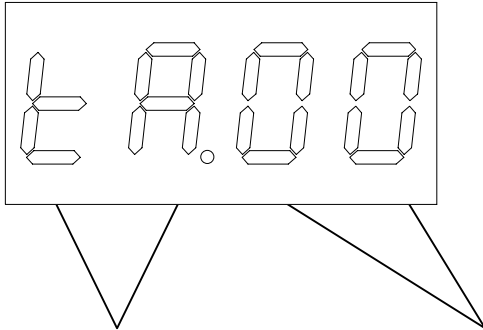

Please turn off DMX signal input (come from the Console) before executing this function.

This function can change dimming level of each channel or all channles to test

Test all channels

Dimming level output

Indicator key:

Press [▶] : test one channel --Increase 1 channel
 eg: Led displays from 0 1.00 to 0 2.00.

Press [◀] : test one channel -- decrease 1 channel
 eg: Led displays from 0 2.00 to 0 1.00.

Press [▲] : Increase dimming level.
 eg: Led displays from 0 8.00 to 0 8. FL .

Press [▼] : Decrease dimming level.
 eg: Led displays from 0 8.FL to 0 8.00 .

Press [CAN] : Function over and restore to last confirmed mode.

Ps.

The dimming level of channles can be saved SC=1 --- SC=6, and recalled by CP-2 control panel.

Please refer to section 5-3.

4-3 Fade in and Fade out automatic testing for each channel or all channles

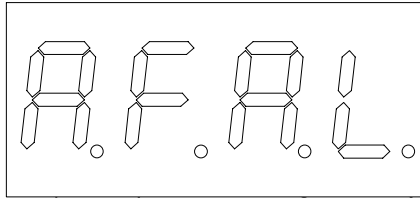

Please turn off DMX signal input before executing this function.

Automatic
Fade in and Fade out

All channles

Indicator key :

Press [**▶**] : auto fade one channel ---- Increase channel.

Press [**◀**] : auto fade one channel ---- decrease channel.

Press [**SEL**] : To confirm.

Press [**CAN**] : Function over and restore to last confirmed mode.

4-4 Display the Voltage

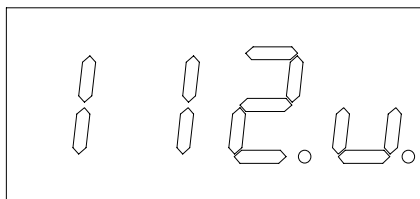

Displays the current AC voltage and will change to 200 - 240VAC automatically if the AC input is 230VAC.

4-5 Display internal temperature

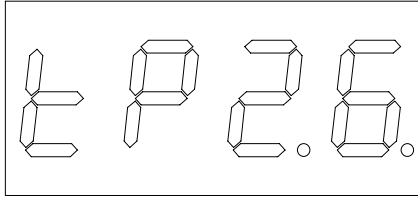

Internal temperature displayed to prevent from overheat and to control the operation of fans.

- (1) **To avoid inhaling dust. the fans controlled by temperature.**
When the internal temperature is over 34°C, the fans start to work 1 minute and stop 1 minute in turn.
- (2) **When the internal temperature is over 37°C, the fans turn continuously**
- (3) **When the internal temperature is over 63°C, all output will be stopped until the temperature goes down 60°C. In this case, please check if the load are verload and the dimmer rack is stuffy.**

Chapter 5. SET

Press "SET" key in turn and the LED will display 6 functions as follows:

- (1) Set dimmer warm-up 0%---6.0%.
(each channel or all channels.)
- (2) Set dimming or switching (non dim) for each channel or all channels.
- (3) 6 memory scenes. (must be connected with CP-2)
- (4) Set fader time: 0.1 SEC.----30 MIN.
- (5) Set Square Law or Linear dimming curve.
- (6) Maximum waltage limit setting.:



CP-2

5-1 Set dimmer- warm up 0 %--- 6.0 %

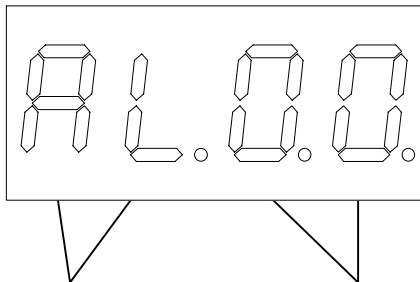

All channles Dimmer-warm up value 0 ~ 6.0%

Indicator key :

Press [▶] : Increase channels.

Press [◀] : Decrease channels.

Press [▲] : Increase dimmer- warm up value.

Press [▼] : Decrease dimmer- warm up value..

Press [CAN] : Function over and restore to last confirmed mode.

P.s. Warm up fuction will not available, If any channel is setted to switching(non dim) .

5-2 Set dimming or switching for each channel or all channels.

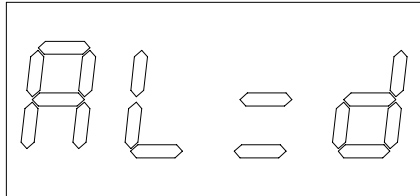

All channles Dimming
(all channles are set with dimming.)

Note:
Make sure your setting is correct before turning on the power.
Never set dim on the channel with a non-dim lamp.

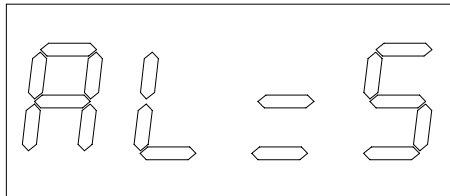

All channles Switching (non dim)
(all channles are set with switching.)

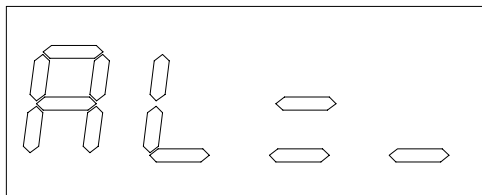

All channles Dimming and Switching mixed.
(all channles can be set dimming or switching.)

NOTE: This information displays when user had previously programmed a mixture of some channels are dimming and some channels are switching (non dimming .)

Indicator key set each channel:

Press [**▶**] : Increase channel.

Press [**◀**] : Decrease channel.

Press [**▲**] : Switching (non dim).

Press [**▼**] : Dimming..

Press [**SEL**] : Select / Confirmation key.

5-3 6 memory scenes -- be Use for architectural lighting with CP-2

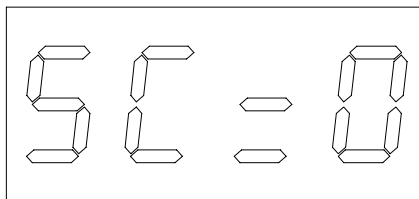

DX-1210/1220/1230/630/640 can be set 6 memory scenes to control architectural lighting by connecting with CP-2 .(Architectural lighting control panel)

Set channels level of DX-1220 series by self test function or by the CONSOLE connect from dmx input or analog in .

Then make a scene memory

Indicator key :

Press [**▶**] : SC=1 → SC=2 → SC=3 → SC=4 → SC=5 → SC=6

Press [**◀**] : SC=6 → SC=5 → SC=4 → SC=3 → SC=2 → SC=1

Press [**SEL**] : Select / Confirmation key.

5-4 Set fader time (be Use for architectural lighting)

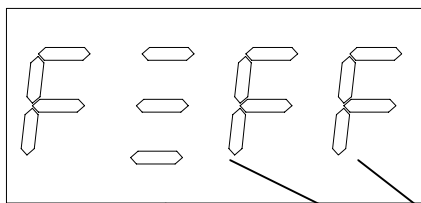

≡ : All channels
 1 : 1st channel
 2 : 2th channel
 3 : 3th channel
 4 : 4th channel
 5 : 5th channel
 6 : 6th channel

≡ : All channels
 1 : 1st channel
 2 : 2th channel
 3 : 3th channel
 4 : 4th channel
 5 : 5th channel
 6 : 6th channel
 7 : 7th channel
 8 : 8th channel
 9 : 9th channel
 A : 10th channel
 B : 11th channel
 C : 12th channel

Set fader time
 (Please refer to section

DX630/640

DX1210/1220/1230

Indicator key :

- Press [▶] : Increase channels.
- Press [◀] : Decrease channels.
- Press [▲] : Extend time.
- Press [▼] : Sorten time..
- Press [SEL] : Select / Confirmation key.

**5-5 The corresponding list of setting fader time
(from 00 --- to FL)**

set	50Hz	60Hz	set	50Hz	60Hz	set	50Hz	60Hz	set	50Hz	60Hz	set	50Hz	60Hz	set	50Hz	60Hz	set	50Hz	60Hz	set	50Hz	60Hz
00	NoFade	NoFade	20	01'22	01'08	40	02'43	02'16	60	04'05	03'24	80	05'37	04'41	A0	12'25	10'21	C0	19'13	16'01	E0	26'01	21'41
01	00'03	00'02	21	01'24	01'10	41	02'46	02'18	61	04'07	03'26	81	05'49	04'51	A1	12'37	10'31	C1	19'25	16'11	E1	26'13	21'51
02	00'05	00'04	22	01'27	01'12	42	02'48	02'20	62	04'10	03'28	82	06'02	05'02	A2	12'50	10'42	C2	19'38	16'22	E2	26'26	22'02
03	00'08	00'06	23	01'29	01'14	43	02'51	02'22	63	04'12	03'30	83	06'15	05'12	A3	13'03	10'52	C3	19'51	16'32	E3	26'39	22'12
04	00'10	00'09	24	01'32	01'17	44	02'53	02'25	64	04'15	03'33	84	06'28	05'23	A4	13'16	11'03	C4	20'04	16'43	E4	26'52	22'23
05	00'13	00'11	25	01'34	01'19	45	02'56	02'27	65	04'18	03'35	85	06'40	05'34	A5	13'28	11'14	C5	20'16	16'54	E5	27'04	22'34
06	00'15	00'13	26	01'37	01'21	46	02'59	02'29	66	04'20	03'37	86	06'53	05'44	A6	13'41	11'24	C6	20'29	17'04	E6	27'17	22'44
07	00'18	00'15	27	01'39	01'23	47	03'01	02'31	67	04'23	03'39	87	07'06	05'55	A7	13'54	11'35	C7	20'42	17'15	E7	27'30	22'55
08	00'20	00'17	28	01'42	01'25	48	03'04	02'33	68	04'25	03'41	88	07'19	06'06	A8	14'07	11'46	C8	20'55	17'26	E8	27'43	23'06
09	00'23	00'19	29	01'45	01'27	49	03'06	02'35	69	04'28	03'43	89	07'31	06'16	A9	14'19	11'56	C9	21'07	17'36	E9	27'55	23'16
0A	00'26	00'21	2A	01'47	01'29	4A	03'09	02'37	6A	04'30	03'45	8A	07'44	06'27	AA	14'32	12'07	CA	21'20	17'47	EA	28'08	23'27
0B	00'28	00'23	2B	01'50	01'31	4B	03'11	02'39	6B	04'33	03'47	8B	07'57	06'37	AB	14'45	12'17	CB	21'33	17'57	EB	28'21	23'37
0C	00'31	00'26	2C	01'52	01'34	4C	03'14	02'42	6C	04'35	03'50	8C	08'10	06'48	AC	14'58	12'28	CC	21'46	18'08	EC	28'34	23'48
0D	00'33	00'28	2D	01'55	01'36	4D	03'16	02'44	6D	04'38	03'52	8D	08'22	06'59	AD	15'10	12'39	CD	21'58	18'19	ED	28'46	23'59
0E	00'36	00'30	2E	01'57	01'38	4E	03'19	02'46	6E	04'41	03'54	8E	08'35	07'09	AE	15'23	12'49	CE	22'11	18'29	EE	28'59	24'09
0F	00'38	00'32	2F	02'00	01'40	4F	03'21	02'48	6F	04'43	03'56	8F	08'48	07'20	AF	15'36	13'00	CF	22'24	18'40	EF	29'12	24'20
10	00'41	00'34	30	02'02	01'42	50	03'24	02'50	70	04'46	03'58	90	09'01	07'31	BO	15'49	13'11	DO	22'37	18'51	FO	29'25	24'31
11	00'43	00'36	31	02'05	01'44	51	03'27	02'52	71	04'48	04'00	91	09'13	07'41	B1	16'01	13'21	D1	22'49	19'01	F1	29'37	24'41
12	00'46	00'38	32	02'08	01'46	52	03'29	02'54	72	04'51	04'02	92	09'26	07'52	B2	16'14	13'32	D2	23'02	19'12	F2	29'50	24'52
13	00'48	00'40	33	02'10	01'48	53	03'32	02'56	73	04'53	04'04	93	09'39	08'02	B3	16'27	13'42	D3	23'15	19'22	F3	30'03	25'02
14	00'51	00'43	34	02'13	01'51	54	03'34	02'59	74	04'56	04'07	94	09'52	08'13	B4	16'40	13'53	D4	23'28	19'33	F4	30'16	25'13
15	00'54	00'45	35	02'15	01'53	55	03'37	03'01	75	04'58	04'09	95	10'04	08'24	B5	16'52	14'04	D5	23'40	19'44	F5	30'28	25'24
16	00'56	00'47	36	02'18	01'55	56	03'39	03'03	76	05'01	04'11	96	10'17	08'34	B6	17'05	14'14	D6	23'53	19'54	F6	30'41	25'34
17	00'59	00'49	37	02'20	01'57	57	03'42	03'05	77	05'03	04'13	97	10'30	08'45	B7	17'18	14'25	D7	24'06	20'05	F7	30'54	25'45
18	01'01	00'51	38	02'23	01'59	58	03'44	03'07	78	05'06	04'15	98	10'43	08'56	B8	17'31	14'36	D8	24'19	20'16	F8	31'07	25'56
19	01'04	00'53	39	02'25	02'01	59	03'47	03'09	79	05'09	04'17	99	10'55	09'06	B9	17'43	14'46	D9	24'31	20'26	F9	31'19	26'06
1A	01'06	00'55	3A	02'28	02'03	5A	03'50	03'11	7A	05'11	04'19	9A	11'08	09'17	BA	17'56	14'57	DA	24'44	20'37	FA	31'32	26'17
1B	01'09	00'57	3B	02'30	02'05	5B	03'52	03'13	7B	05'14	04'21	9B	11'21	09'27	BB	18'09	15'07	DB	24'57	20'47	FB	31'45	26'27
1C	01'11	01'00	3C	02'33	02'08	5C	03'55	03'16	7C	05'16	04'24	9C	11'34	09'38	BC	18'22	15'18	DC	25'10	20'58	FC	31'58	26'38
1D	01'14	01'02	3D	02'36	02'10	5D	03'57	03'18	7D	05'19	04'26	9D	11'46	09'49	BD	18'34	15'29	DD	25'22	21'09	FD	32'10	26'49
1E	01'17	01'04	3E	02'38	02'12	5E	04'00	03'20	7E	05'21	04'28	9E	11'59	09'59	BE	18'47	15'39	DE	25'35	21'19	FE	32'23	26'59
1F	01'19	01'06	3F	02'41	02'14	5F	04'02	03'22	7F	05'24	04'30	9F	12'12	10'10	BF	19'00	15'50	DF	25'48	21'30	FF	32'36	27'10

5-6 Set "square law " or " linear" dimming curve

Square law dimming curve : C2

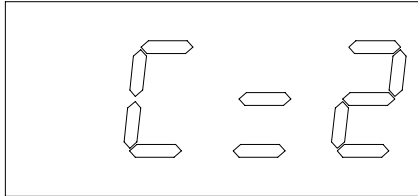

Linear dimming curve : C3

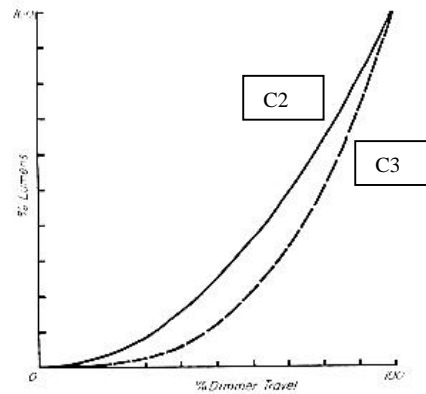
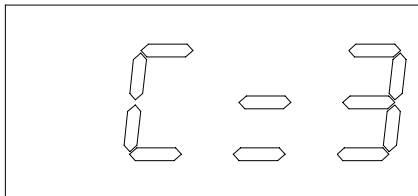

Indicator key :

Press [▲] : Change dimming curve

Press [▼] : Change dimming curve

Press [SEL] : Select / Confirmation key.

5-7 Maximum Output Waltage Limit Setting :

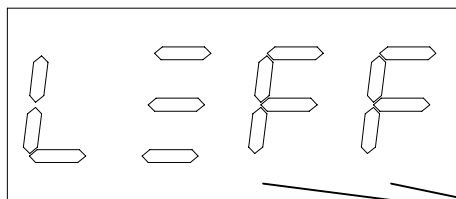

**Maximum waltage limit setting
From 50%---FF% (Full lighting)**

- ≡ : All channels
- 1 : 1st channel
- 2 : 2th channel
- 3 : 3th channel
- 4 : 4th channel
- 5 : 5th channel
- 6 : 6th channel
- 7 : 7th channel
- 8 : 8th channel
- 9 : 9th channel
- A : 10th channel
- B : 11th channel
- C : 12th channel

DX1210/1220/1230

- ≡ : All channels
- 1 : 1st channel
- 2 : 2th channel
- 3 : 3th channel
- 4 : 4th channel
- 5 : 5th channel
- 6 : 6th channel

DX-630/640

Indicator key :

Press [**▶**] : Increase channels.

Press [**◀**] : Decrease channels.

Press [**▲**] : Increase percentage of waltage

Press [**▼**] : Decrease percentage of waltage.

Press [**SEL**] : Select / Confirmation key.

Chapter 6. Specification of plug & wiring diagram

REAR PANEL

SOCKET TYPE : GERMAN (SCHUKO)

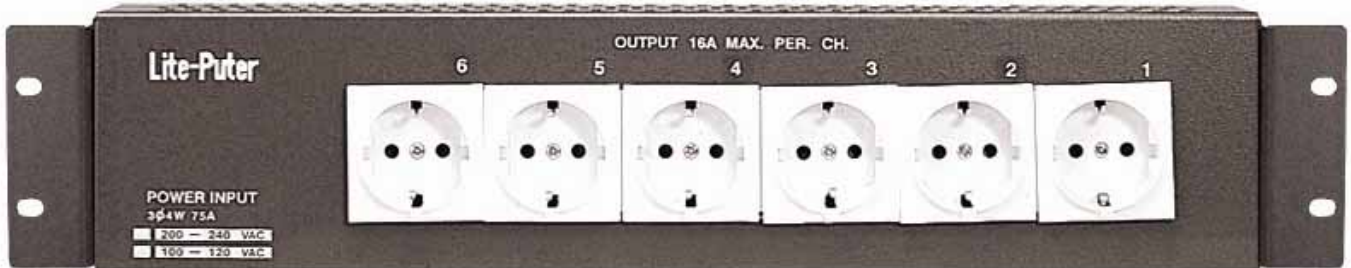

SOCKET TYPE : UK

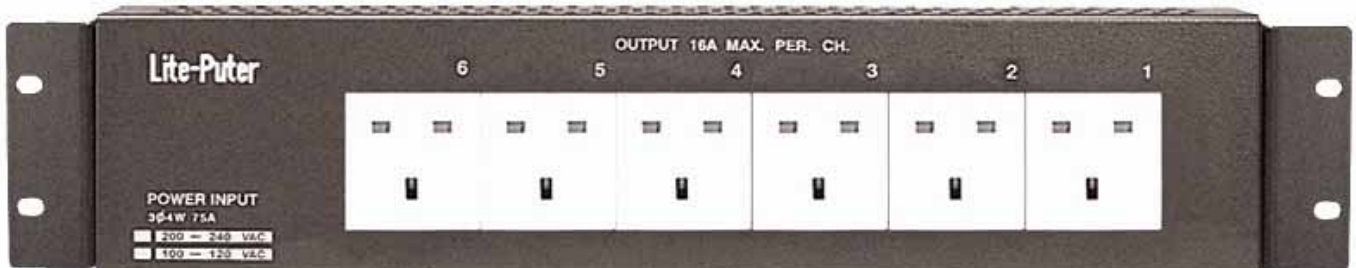

SOCKET TYPE : FRENCH



REAR PANEL

SOCKET TYPE : SOCAPEX 19 PIN



SOCKET TYPE : USA



SOCKET TYPE : AUSTRALIA

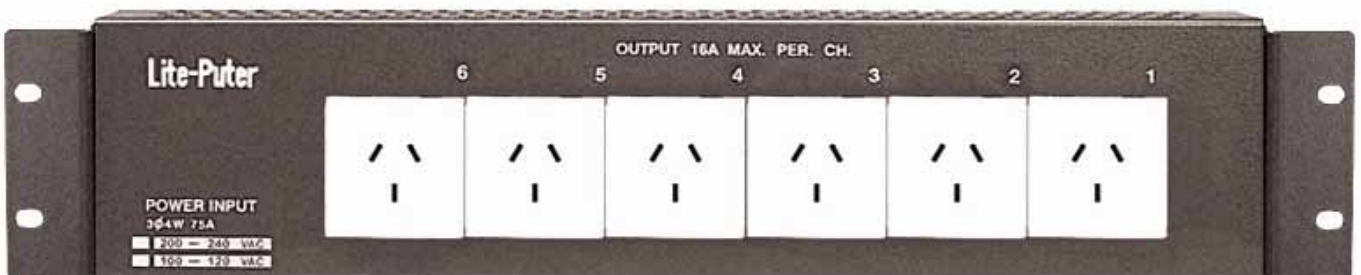



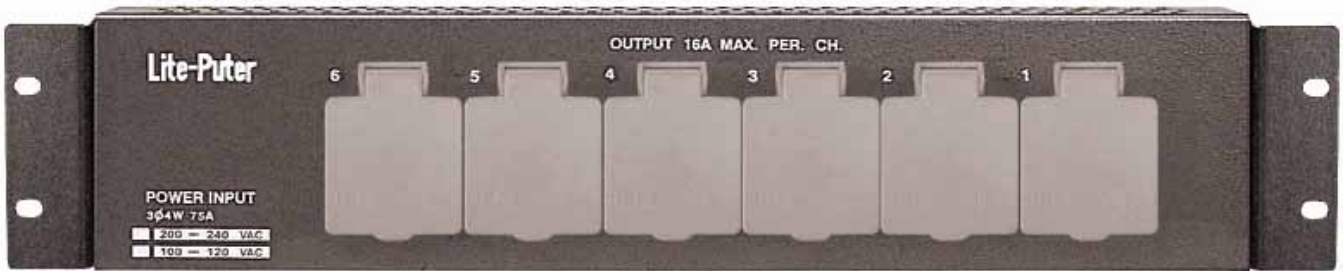

REAR PANEL

ANOTHER TYPE:

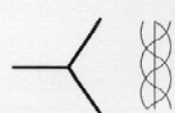
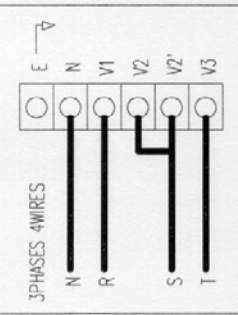
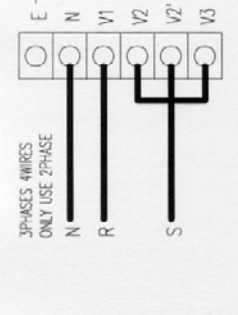
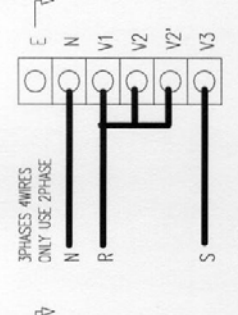
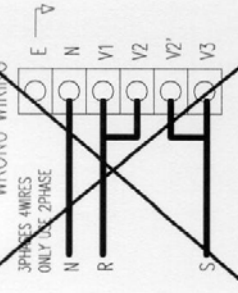

Wiring diagram of DX-1210/1220/1230/630/640

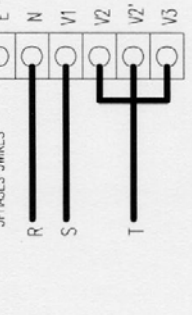
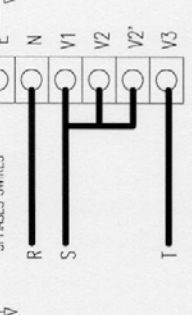
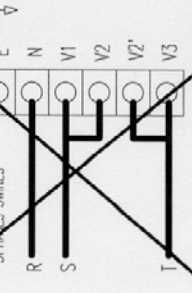
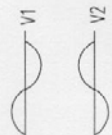
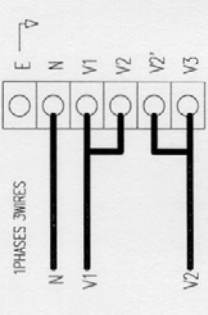
LITE-PUTER 970805

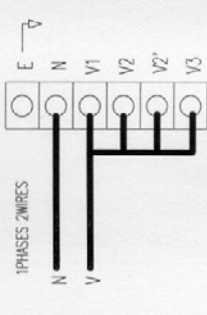
<p>3PHASES 4WIRES</p> 	<p>THE BEST WIRING DIAGRAM</p>  <p>3PHASES 4WIRES ONLY USE 2PHASE</p>	 <p>3PHASES 4WIRES ONLY USE 2PHASE</p>	 <p>3PHASES 4WIRES ONLY USE 2PHASE</p>	<p>WRONG WIRING</p>  <p>3PHASES 4WIRES ONLY USE 2PHASE</p>
<p>3PHASE 3WIRES</p> 	<p>3PHASES 3WIRES SYSTEM IS NOT GOOD FOR ILLUMINATION BUT 2 OF DIAGRAMS ON RIGHT SIDE ARE OUR SUGGESTION</p>	 <p>3PHASES 3WIRES</p>	 <p>3PHASES 3WIRES</p>	<p>WRONG WIRING</p>  <p>3PHASES 3WIRES</p>
<p>SINGLE PHASE 3WIRES</p> 	<p>USED FOR SINGLE PHASE ONLY</p>  <p>1PHASES 3WIRES</p>	<p>USED FOR SINGLE PHASE ONLY! SPECIAL DESIGN FOR JAPANESE MARKET.</p>		
<p>SINGLE PHASE 2WIRES</p> 	 <p>1PHASES 2WIRES</p>			
<p>NOTE</p>	<p>*** ANY TIME V2 AND V2' MUST BE CONNECTED TO SAME PHASE</p>			

Lite-Puter

Lite-Puter Enterprise Co., Ltd.

9F1., No. 196, Sec. 3, Datug Rd., Shijr City, TAIPEI, TAIWAN

TEL: 886-2-8647-2929 / 886-2-8647-2828

FAX: 886-2-8647-2727 / 886-2-8647-2626

Website: <http://www.liteputer.com.tw>

E-mail: sales@liteputer.com.tw